



CURETTES



LONG HANDLE CURETTES

STRAIGHT

15" overall length 9" handle 380mm 230mm handle

SIZE STRAIGHT ANGLED REV. ANGLED

3/0 710-1530-0 710-1530-1 710-1530-2

2/0 710-1520-0 710-1520-1 710-1520-2

0 710-1500-0 710-1500-1 710-1500-2 1 710-1501-0 710-1501-1
710-1501-2

2 710-1502-0 710-1502-1 710-1502-2

3 710-1503-0 710-1503-1 710-1503-2

4 710-1504-0 710-1504-1 710-1504-2

5 710-1505-0 710-1505-1 710-1505-2

6 710-1506-0 710-1506-1 710-1506-2

7 710-1507-0 710-1507-1
710-1507-2

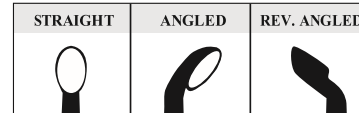

Also available in 13" length 7" handle and
15" length 7" handle. See
www.lifeinstruments.com for details.

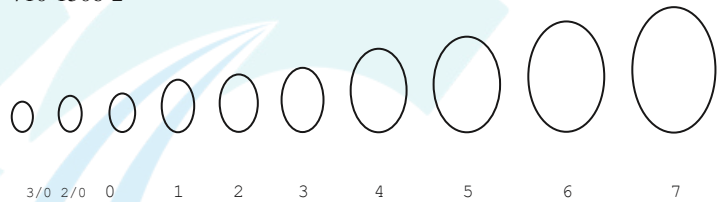

O'BRIEN CURETTE

15" overall length 9" handle 380mm 230mm handle

8mm 719-1508-0

11mm 719-1511-0



CHARNLEY CURETTE

15" overall length 9" handle 380mm 230mm handle

719-1501-0

719-1502-0

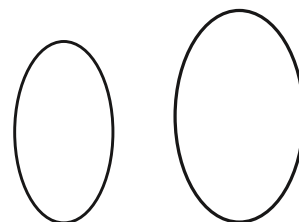

Small

Large

Small
Large





COUTTS SCOOP
15" overall length 380mm

- 716-1504-1 Angled Right #4
- 716-1504-2 Angled Left #4

CURETTES



TOOTHED LONG HANDLE CURETTE
15" overall length 9" handle 380mm

- SIZE**
- 4 710-1504-0T
 - 5 710-1505-0T
 - 6 710-1506-0T 7
710-1507-0T



REVISION CURETTE
21.5" overall length 545mm

- SIZE**
- 3 715-2153-1 ANGLED
 - 4 715-2154-1 ANGLED
 - 5 715-2155-1 ANGLED
 - 6 715-2156-1 ANGLED



COBB CURETTES
11" overall length 280mm

- | SIZE | STRAIGHT | ANGLED |
|------|------------|--|
| 4/0 | 811-1140-0 | 811-1140-1 |
| 3/0 | 811-1130-0 | 811-1130-1 |
| 2/0 | 811-1120-0 | 811-1120-1 0 811-1100-0 811-1100-1 1 811-1101-0 811-1101-1 2 811-1102-0 811-1102-1 3 |

811-1103-0 811-1103-1 4 811-1104-0
 811-1104-1 5 811-1105-0 811-1105-1
 6 811-1106-0 811-1106-1

ELEVATORS



LONG HANDLE COBB ELEVATORS

15" overall length 9" handle 380mm

SIZE	15" LENGTH	13" LENGTH
1/2"	720-1512-0	720-1312-0
5/8"	720-1558-0	720-1358-0
3/4"	720-1534-0	720-1334-0
1"	720-1510-0	720-1310-0
30mm	720-1530-0	720-1330-0

Custom lengths and widths available upon request.



SUCTION LONG HANDLE COBB ELEVATOR

15" overall length 9" handle

3/4"	720-1534-0-1L	Suction Left
3/4"	720-1534-0-1R	Suction Right

SHAMIM CORPORATION



SMALL ELEVATOR

10" overall length 5" handle 250mm

1/4"	721-1025-0
3/8"	721-1038-0
1/2"	721-1012-0



Serrations

AUFRANC ELEVATOR

10" overall length 250mm

724-1012-0

ELEVATORS



JACK ELEVATOR
11" overall length Blunt 1" width
 723-1101-0



LONG PENFIELD #2

PENFIELD DISSECTORS 8.5" overall length	215mm	10.5" overall length	265mm
SIZE		SIZE	
#2		#2	725-1028-0
#3	725-8028-0 725-8038-0	#3	725-1038-0
#4	725-8044-0	#4	725-1054-0
3mm #4	725-8043-0		

All penfields have black knurled handle for better feel and control.



7.5 mm

MICRO COBB ELEVATORS 8.5" overall length 215mm

SIZE	
3mm	722-8030-0
4mm	722-8040-0
7.5mm	722-8075-0
<i>Available upon request</i>	
2mm	722-8020-0

Excellent for dissecting the ligamentum flavum.



CURVED CHISEL & ELEVATOR
7 3/4" overall length 195mm Excellent for removing tissue on bone grafts.
 726-7345-1

ELEVATORS



FREER ELEVATOR

7.5" double ended 190mm

4mm 726-7514-0



COBB ELEVATOR

11" overall length 280mm

SIZE	11" LENGTH
1/4"	821-1114-0
3/8"	821-1138-0
1/2"	821-1112-0
3/4"	821-1134-0
1"	821-1101-0

9" overall length 230mm

SIZE	9" LENGTH
1/4"	821-9114-0 1/2"
	821-9112-0
3/4"	821-9134-0



KEY PERIOSTEAL ELEVATOR

SIZE	LENGTH
1/8"	6.34" 822-6718-0
1/4"	6.34" 822-6714-0
3/8"	7.5" 822-7538-0
1/2"	7.5" 822-7512-0
5/8"	7.5" 822-7558-0
3/4"	8" 822-0834-0
1"	8" 822-0801-0



SHAMIM CORPORATION

LANGENBECK ELEVATOR

9" overall length 230mm

728-9016-0

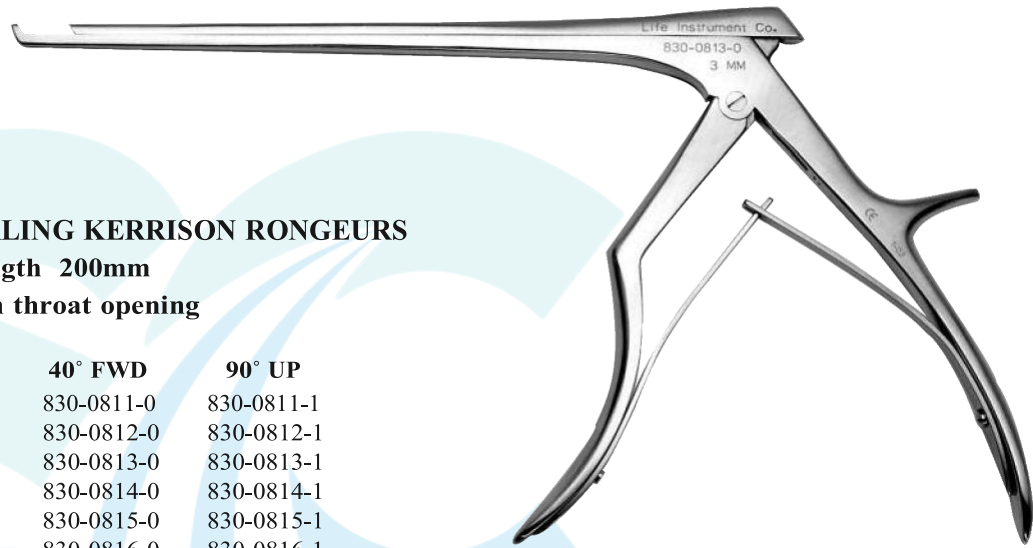

SPURLING KERRISON RONGEURS
8" length 200mm
15mm throat opening

40° FWD	90° UP
830-0811-0	830-0811-1
830-0812-0	830-0812-1
830-0813-0	830-0813-1
830-0814-0	830-0814-1
830-0815-0	830-0815-1
830-0816-0	830-0816-1

SIZ
E
1m
m
2m
m
3m
m
4m
m
5m
m
6m
m

SHAMIM CORPORATION



KERRISON RONGEURS

8" length 200mm

SIZE	40° FWD	90° UP	90° DWN
1mm	830-0801-0	830-0801-1	830-0801-2
2mm	830-0802-0	830-0802-1	830-0802-2
3mm	830-0803-0	830-0803-1	830-0803-2
4mm	830-0804-0	830-0804-1	830-0804-2
5mm	830-0805-0	830-0805-1	830-0805-2
6mm	830-0806-0	830-0806-1	830-0806-2

10" length 250mm

SIZE	40° FWD	90° UP	90° DWN
1mm	830-1001-0	830-1001-1	830-1001-2
2mm	830-1002-0	830-1002-1	830-1002-2
3mm	830-1003-0	830-1003-1	830-1003-2
4mm	830-1004-0	830-1004-1	830-1004-2
5mm	830-1005-0	830-1005-1	830-1005-2
6mm	830-1006-0	830-1006-1	830-1006-2

12" length 300mm

SIZE	40° FWD	90° UP	90° DWN
2mm	830-1202-0	830-1202-1	830-1202-2
3mm	830-1203-0	830-1203-1	830-1203-2
4mm	830-1204-0	830-1204-1	830-1204-2
5mm	830-1205-0	830-1205-1	830-1205-2
6mm	830-1206-0	830-1206-1	830-1206-2

RONGEURS

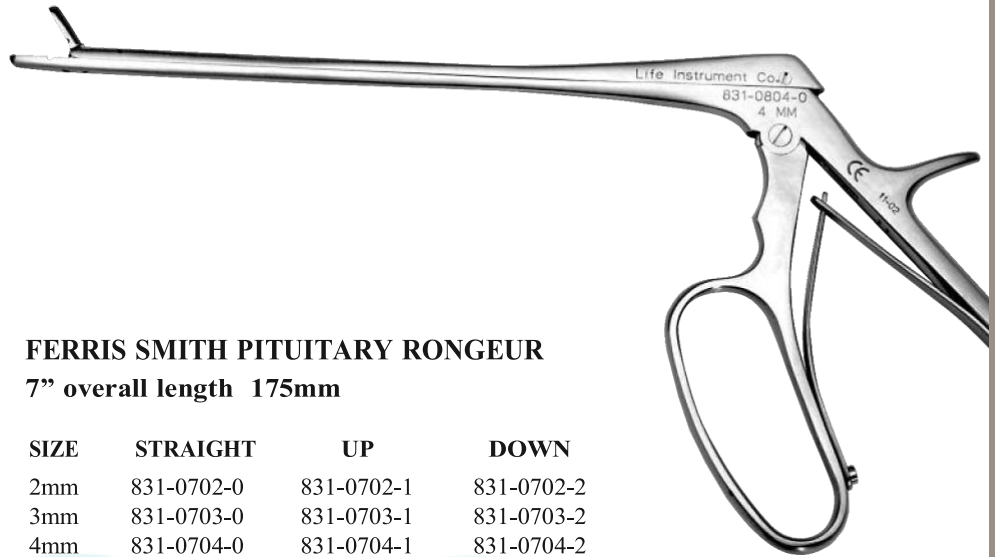

FERRIS SMITH PITUITARY RONGEUR

7" overall length 175mm

SIZE	STRAIGHT	UP	DOWN
2mm	831-0702-0	831-0702-1	831-0702-2
3mm	831-0703-0	831-0703-1	831-0703-2
4mm	831-0704-0	831-0704-1	831-0704-2
5mm	831-0705-0	831-0705-1	831-0705-2

8" overall length 200mm

SIZE	STRAIGHT	UP	DOWN
2mm	831-0802-0	831-0802-1	831-0802-2
3mm	831-0803-0	831-0803-1	831-0803-2
4mm	831-0804-0	831-0804-1	831-0804-2
5mm	831-0805-0	831-0805-1	831-0805-2

10" overall length 250mm

SIZE	STRAIGHT	UP	DOWN
2mm	831-1002-0	831-1002-1	831-1002-2
3mm	831-1003-0	831-1003-1	831-1003-2
4mm	831-1004-0	831-1004-1	831-1004-2
5mm	831-1005-0	831-1005-1	831-1005-2
6mm	831-1006-0	831-1006-1	831-1006-2

12" overall length 300mm

SIZE	STRAIGHT	UP	DOWN
2mm	831-1202-0	831-1202-1	831-1202-2
3mm	831-1203-0	831-1203-1	831-1203-2
4mm	831-1204-0	831-1204-1	831-1204-2
5mm	831-1205-0	831-1205-1	831-1205-2
6mm	831-1206-0	831-1206-1	831-1206-2

SHAMIM CORPORATION

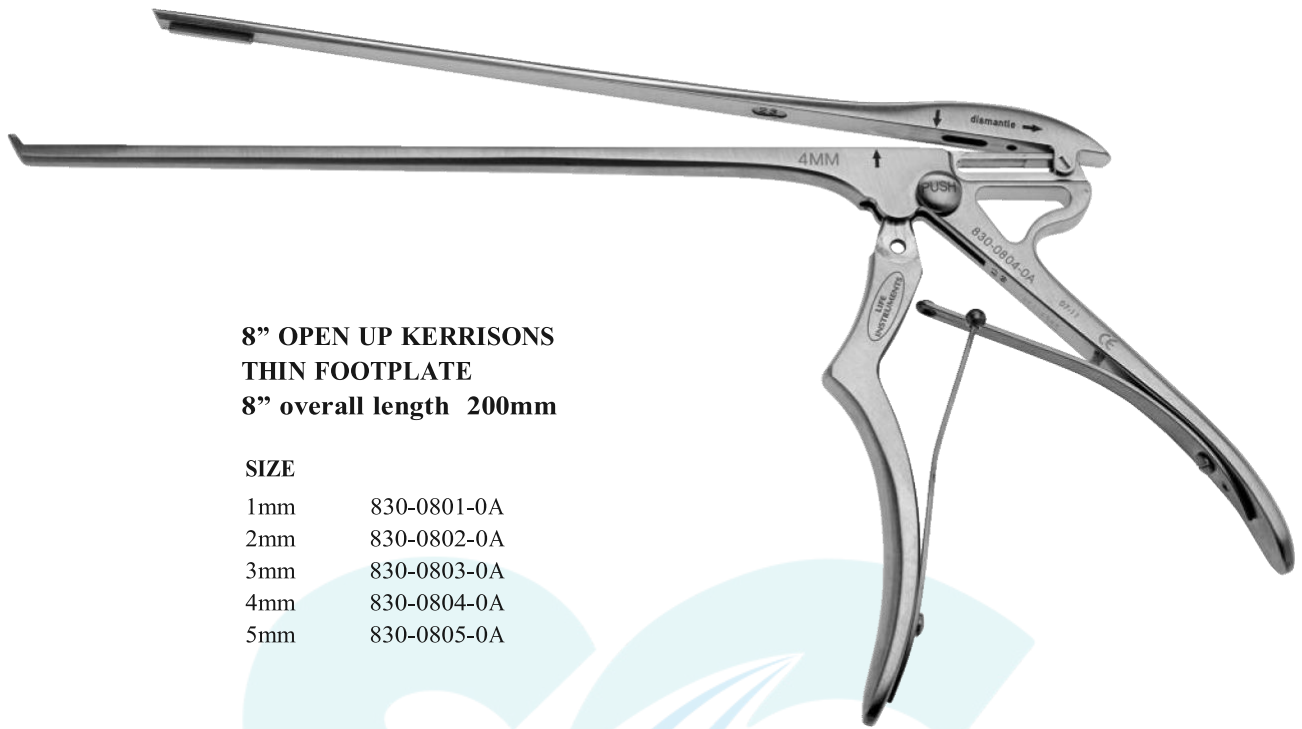

**8" OPEN UP KERRISONS
THIN FOOTPLATE
8" overall length 200mm**

SIZE

1mm	830-0801-0A
2mm	830-0802-0A
3mm	830-0803-0A
4mm	830-0804-0A
5mm	830-0805-0A

Easy to Disassemble • Great for Cleaning



8" OPEN UP KERRISON STERILIZATION TRAY WITH COVER

Holds 5 Take-Apart Kerrisons

Outer Dimensions: 10" x 21.5" x 1.5"

702-2110-1

RONGEURS

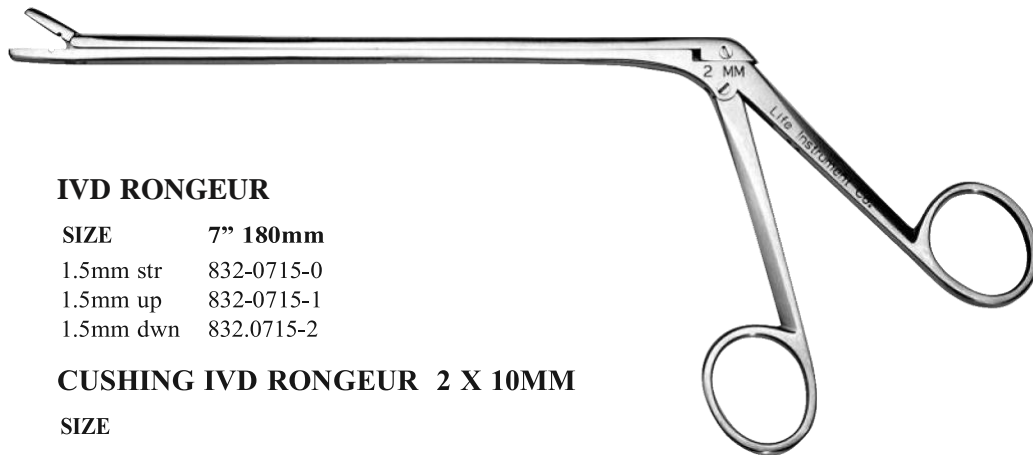

IVD RONGEUR

SIZE	7" 180mm
1.5mm str	832-0715-0
1.5mm up	832-0715-1
1.5mm dwn	832.0715-2

CUSHING IVD RONGEUR 2 X 10MM

SIZE

7" 175mm

9" 230mm

2mm str	832-0702-0	832-0902-0
2mm up	832-0702-1	832-0902-1
2mm dwn	832-0702-2	832-0902-2

LOVE IVD RONGEUR 3 X 10MM

SIZE	7" 175mm	9" 230mm
3mm str	832-0703-0	832-0903-0
3mm up	832-0703-1	832-0903-1
3mm dwn	832-0703-2	832-0903-2

SPURLING IVD RONGEUR 4 X 10MM

SIZE	7" 175mm	9" 230mm
4mm str	832-0704-0	832-0904-0
4mm up	832-0704-1	832-0904-1
4mm dwn	832-0704-2	832-0904-2

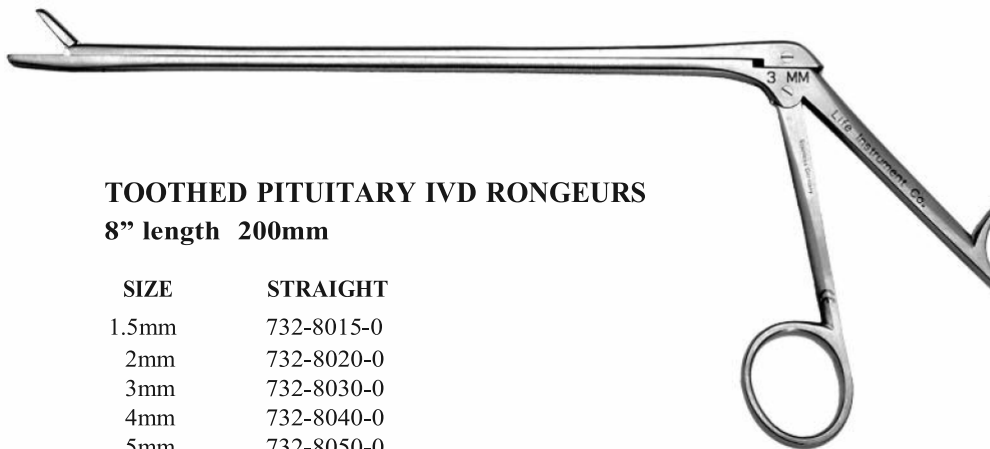

TOOTHED PITUITARY IVD RONGEURS

8" length 200mm

SIZE	STRAIGHT
1.5mm	732-8015-0
2mm	732-8020-0
3mm	732-8030-0
4mm	732-8040-0
5mm	732-8050-0

SIZE	10" 250mm	12" 300mm
2mm	732-1020-0	732-1220-0
3mm	732-1030-0	732-1230-0
4mm	732-1040-0	732-1240-0
5mm	732-1050-0	732-1250-0

TOOTHED PITUITARY RONGEUR

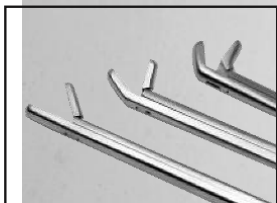
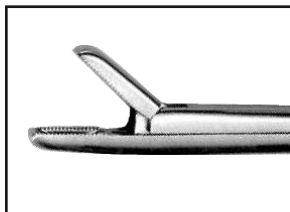

HEAVY DUTY RONGEUR

10" length 250mm

8mm Straight	832-1008-0
8mm Angled 30° up	832-1008-1
8mm Angled 60° up	832-1008-2
8mm Straight with Teeth	832-1018-0

12" length 300mm

8mm Straight	832-1208-0
8mm Straight with Teeth	832-1218-0

SHAMIM CORPORATION

RONGEURS



LESKELL RONGEUR

9" length 230mm

	SLIGHT CURVE	FULL CURVE
8mm	834-0918-0	834-0914-1 834-0918-1

TOOTHED LEKSELL RONGEUR

9" length 230mm

834-0904-0
834-0908-0

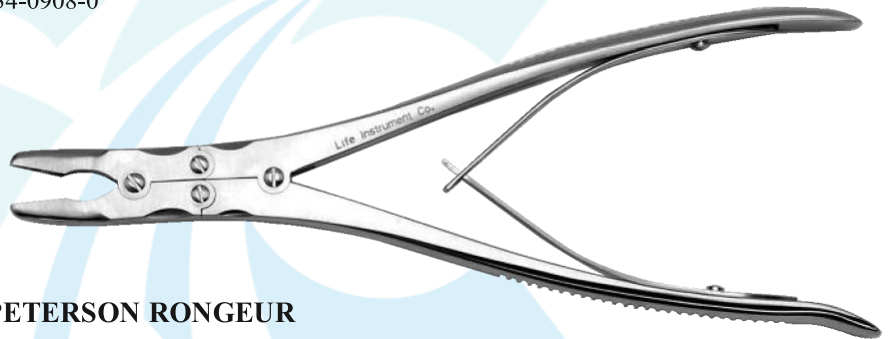

SMITH PETERSON RONGEUR

9" length 230mm

SIZE
4mm 834-0914-0

SHAMIM CORPORATION

SIZE
4mm
8mm

SIZE	STRAIGHT	ANGLED
2mm	836-9502-0	836-9502-1

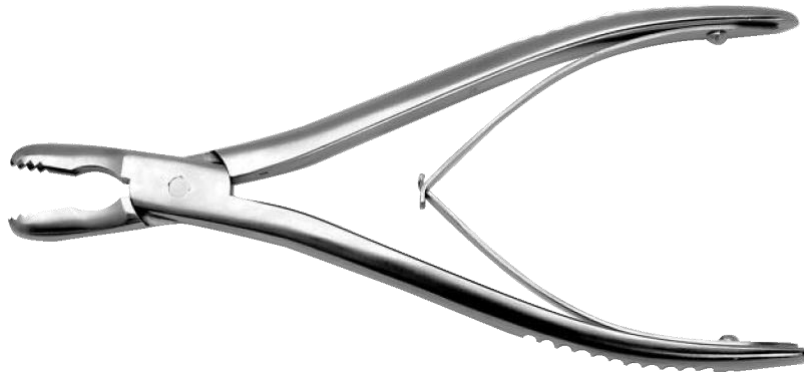

4mm	836-9504-0	836-9504-1
6mm	836-9506-0	836-9506-1
7mm	836-9507-0	836-9507-1

ADSON RONGEUR
8" length 200mm

8mm smooth 834-0818-0 8mm teeth
 834-0808-0

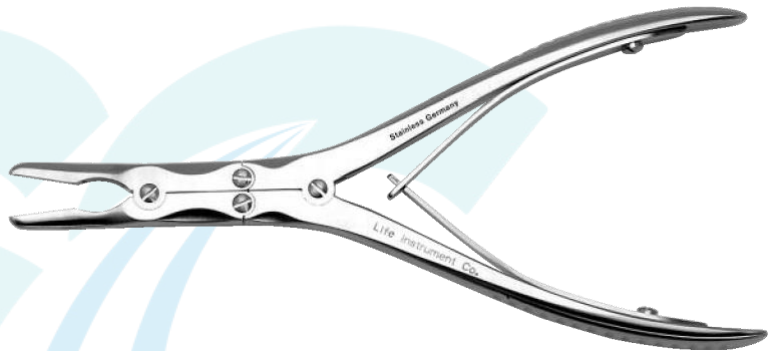

BEYER
RONGEUR
7" length 175mm

3mm 834-0703-1 Slight curve

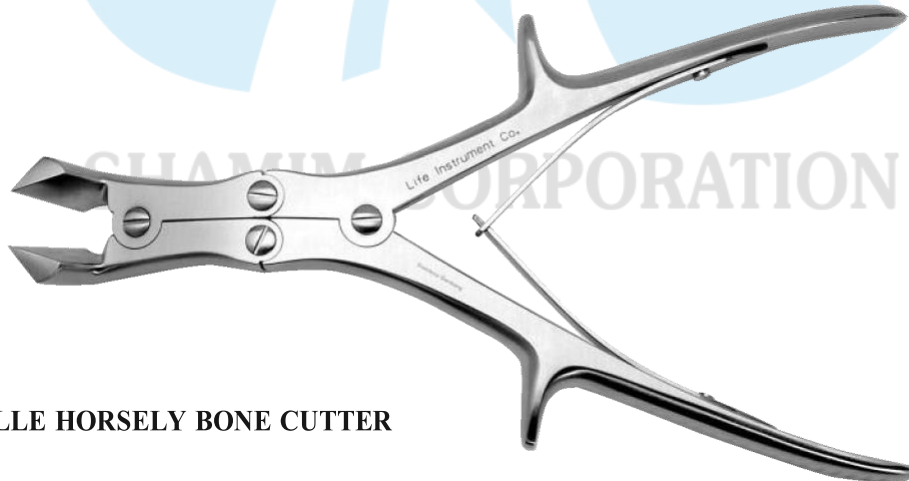

STILLE HORSELY BONE CUTTER

836-1212-0

RONGEURS



EXTRA LONG DOUBLE ACTION RONGEUR 14" length 355mm

		With teeth	
5mm	873-1405-0	5mm	873-1405-0T
8mm	873-1408-0	8mm	873-1408-0T
12mm	873-1412-0	12mm	873-1412-0T



SHAMIM CORPORATION



SHAMIM CORPORATION



AUFRANC COBRA RETRACTOR WITH LIFE HANDLE

742-1215-1



COBRA RETRACTOR

742-1215-0



WIDE COBRA RETRACTOR

742-1225-1

SHAMIM CORPORATION



BELLY COBRA RETRACTOR

742-1240-1

RETRACTORS



COBRA RETRACTOR EXTRA DEEP

742-1210-0

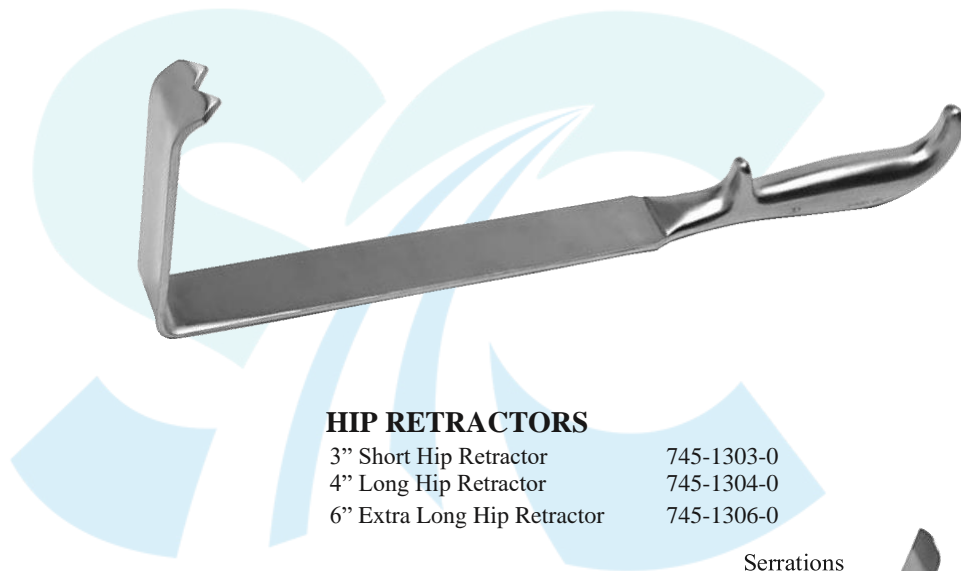

HIP RETRACTORS

- | | |
|-----------------------------|------------|
| 3" Short Hip Retractor | 745-1303-0 |
| 4" Long Hip Retractor | 745-1304-0 |
| 6" Extra Long Hip Retractor | 745-1306-0 |

Serrations

SHAMIM CORPORATION



AUFRANC ELEVATOR & SHORT HIP RETRACTOR

745-1238-0

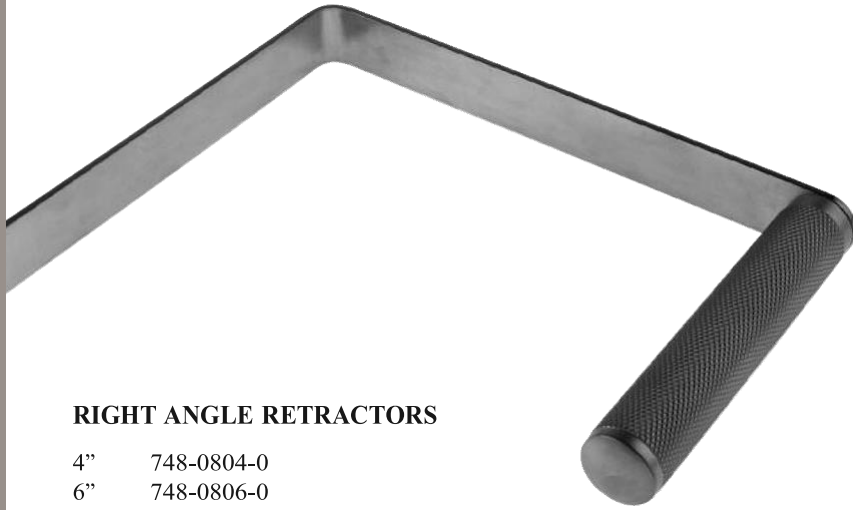

RIGHT ANGLE RETRACTORS

- 4" 748-0804-0
- 6" 748-0806-0
- 8" 748-0808-0

Handle can be 90° reversed upon request.



MCELROY

RETRACTOR

5" depth 125mm

- 9" 740-0901-0
- 11" 740-1101-0
- 13" Extra Long 740-1301-0

SHAMIM CORPORATION



BONE HOOK

- 10" overall length 748-1020-1 5" Handle
- 12" overall length 748-1220-1 7" Handle

RETRACTORS



FEMORAL SHAFT RETRACTOR

742-1302-0



PROXIMAL FEMORAL SHAFT RETRACTOR

742-1415-1



BENNETT RETRACTOR

10" length 260mm

		1.75"	45mm	745-1045-0
2.25"	60mm	745-1060-0		
3.25"	80mm	745-1080-0		



ERSE
TRACTOR

HOHMANN

KNEE

Z-TRACTOR

744-0899-0

18-0



HIBBS RETRACTORS

9.5" length 240mm

- 3" 840-9503-0
- 4" 840-9504-0



HOHMANN RETRACTOR

9.25" length 235mm

10mm 743-9510-0 18mm 743-9518-0

- 25mm 743-9525-0
- 43mm 743-9543-0

9.75" length 250mm

70mm 743-9570-0 **MINI**

HOHMANN RETRACTOR

6.5" length 166mm

- 6mm 743-6506-0
- 8mm 743-6508-0

RETRACTORS



KOLBEL RETRACTOR FRAME

745-0001-0



KOLBEL BLADES

SIZE width x length Set of 2

x 36	745-2036-0
x 36	745-3636-0
x 53	745-2053-0
x 53	745-3653-0
x 68	745-2068-0
x 68	745-3668-0



FAKUDA RETRACTOR

Small 29mm 745-0029-0
Large 36mm 745-0036-0



DELTOID RETRACTOR

745-1101-0

NERVE ROOT RETRACTOR

10.5" length 265mm

Regular 8.5"	215mm	746-8520-0
Fine 10.5"	265mm	746-1020-1
Regular 10.5"	265mm	746-1020-0



SENN RETRACTOR

6" length 150mm

Sharp	744-0603-0
Blunt	744-0613-0



BABY BENNETT RETRACTOR

6" length 150mm

743-0638-1

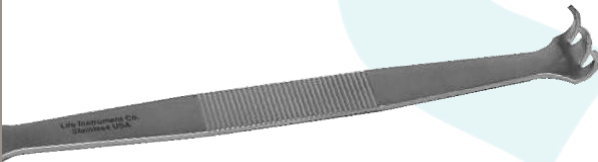

MULTI-USE RETRACTOR

6.75" length 170mm

743-6753-0



HERNIA RETRACTOR

6" length 150mm

7mm	744-0607-0
10mm	744-0610-0
14mm	744-0614-0

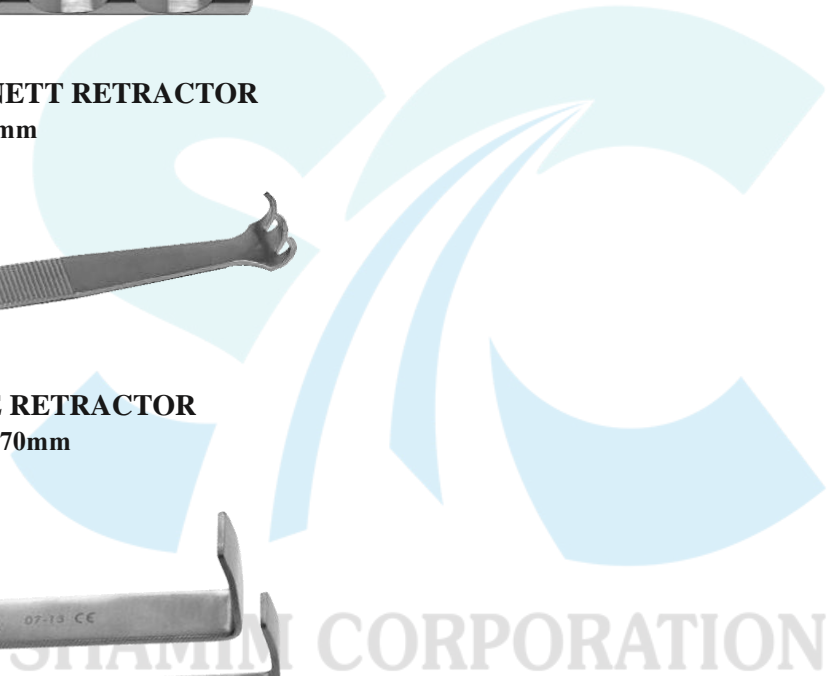

SELF-RETAINING RETRACTORS



ZELPI® RETRACTOR 90°

5" Exposure

3"	741-1230-2
4"	741-1240-2
5"	741-1250-2

Also available

1.5"	741-1215-2
2"	741-1220-2



ZELPI® WITH CEREBELLAR TIPS

3.5" Length

90°	741-1244-2
45°	741-1244-3

Different lengths available upon request

SHAMIM CORPORATION



**ZELPI® CEREBELLAR 90°
GELPI STYLE RATCHET**

3" 741-1234-2-1

SELF-RETAINING RETRACTORS

DEEP GELPI RETRACTOR 3"

741-1030-0



90°

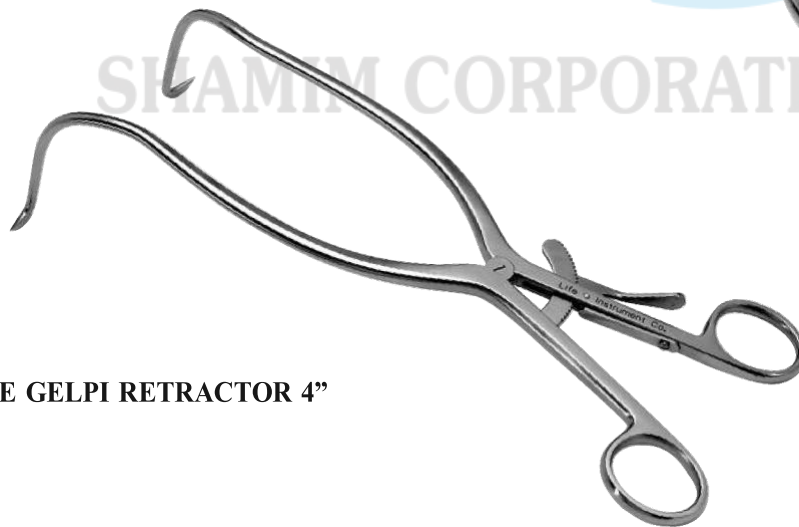

WILTSE GELPI RETRACTOR 4"

741-1240-0



WEITLANDER RETRACTOR

3 x 4 prongs

SIZE

5 1/2" 741-5501-0

6 1/2" 741-6500-0

7 3/4" 741-7750-0

9" 741-0900-0

Please indicate blunt tips by adding "B" to the end of the part number.

RETRACTORS



SMALL

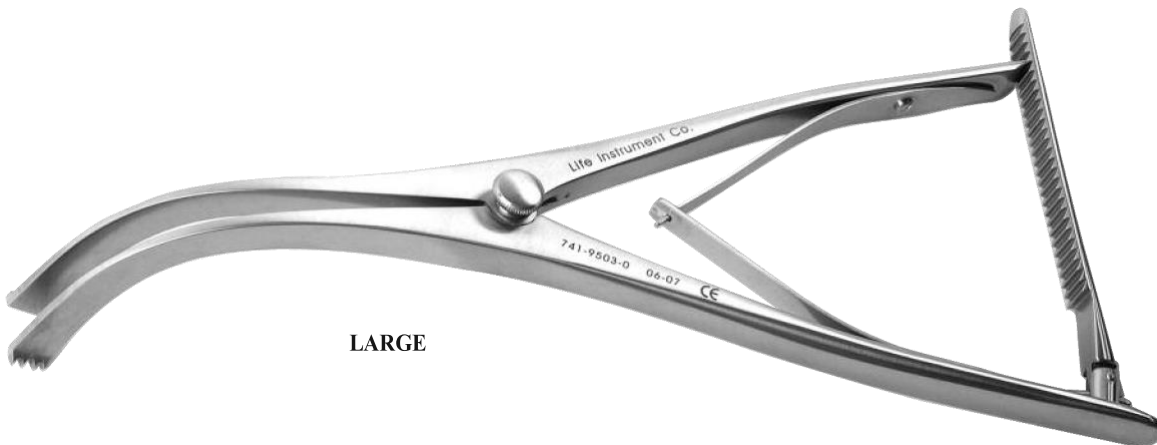

LARGE

INGE LAMINA SPREADER

Small 6.5" 741-6506-0
Small 6.5" 741-6506-0S with Spindle Large
10" 741-9503-0



LAMINA SPREADER WITH LOCKING SPINDLE

3" Deep 741-9503-0S
5" Deep 741-9505-0S

RETRACTORS



ILIAC CREST RETRACTORS

Adult 740-9030-0
Pediatric 740-8015-0

SHIM CORPORATION



MICRO TAYLOR RETRACTORS

Blade width 3/4" 19mm

SIZE

2"	50mm	748-9512-0
3"	75mm	748-9513-0
4"	100mm	748-9514-0
5"	125mm	748-9515-0
6"	150mm	748-9516-0

TAYLOR RETRACTOR

Blade width 1 1/4" 30mm

3"	75mm	748-9503-0
4"	100mm	748-9504-0
6"	150mm	748-9506-0



**MEYERDING
RETRACTORS**

SIZE

17mm x 55mm	748-0917-0
25mm x 80mm	748-0925-0
25mm x 125mm	748-0925-L
25mm x 150mm	748-0925-LC
50mm x 94mm	748-0950-0

SHARP CORPORATION



OSTEOTOMES

10.75" overall length 5" handle 270mm

SIZE	MM	STRAIGHT	CURVED
1/4"	6mm	750-1025-0	750-1025-1
3/8"	9mm	750-1038-0	750-1038-1
1/2"	13mm	750-1012-0	750-1012-1
5/8"	16mm	750-1058-0	750-1058-1
3/4"	19mm	750-1034-0	750-1034-1
1"	25mm	750-1010-0	750-1010-1



CHISELS

10.75" overall length 5" handle 270mm

SIZE	MM	STRAIGHT	CURVED
1/4"	6mm	751-1025-0	751-1025-1
3/8"	9mm	751-1038-0	751-1038-1
1/2"	13mm	751-1012-0	751-1012-1
5/8"	16mm	751-1058-0	751-1058-1
3/4"	19mm	751-1034-0	751-1034-1
1"	25mm	751-1010-0	751-1010-1



GOUGES

10.75" overall length 5" handle 270mm

SIZE	MM	STRAIGHT	CURVED
REVERSE CURVE			
1/4"	6mm	753-1014-0	753-1014-1753-1014-2
3/8"	9mm	753-1038-0	753-1038-1753-1038-2
1/2"	13mm	753-1012-0	753-1012-1753-1012-2
5/8"	16mm	753-1058-0	753-1058-1753-1058-2
3/4"	19mm	753-1034-0	753-1034-1753-1034-2

OSTEOTOMES, GOUGES & CHISELS

1"	25mm	753-1010-0	753-1010-1753-
1010-2			
1/4"	3/8"	1/2"	5/8"
3/4"	1"		



OSTEOTOMES, GOUGES & CHISELS

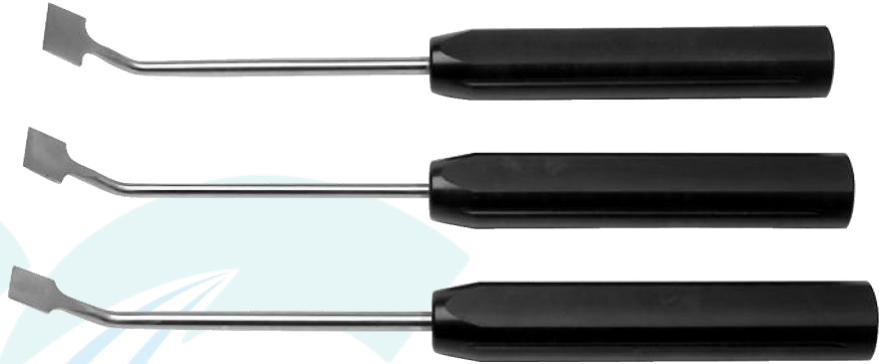

MILLIS OSTEOTOMES

30° angle

14mm	759-1314-1
19mm	759-1319-1
25mm	759-1325-1

45° angle

14mm	759-1314-2
19mm	759-1319-2
25mm	759-1325-2

For Pelvic osteotomy procedure.

SHAMIM CORPORATION MILLIS CRESCENT OSTEOTOMES

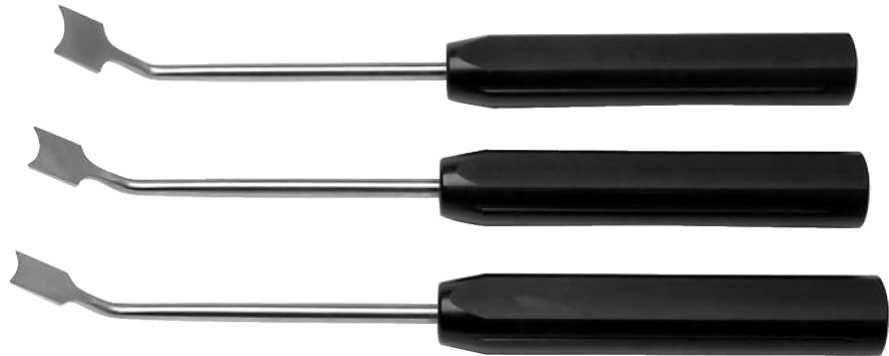

Straight

14mm	759-1314-0
19mm	759-1319-0

30° angle

14mm	759-1314-3
19mm	759-1319-3

25mm 759-1325-3

45° angle

14mm 759-1314-4
19mm 759-1319-4
25mm 759-1325-4



LONG OSTEOTOMES

15" overall
length 5"

handle

380mm

SIZE

STRAIGHT

1/4" 6mm

750-1514-0

3/8" 9mm

750-1538-0

1/2" 13mm

750-1512-0



**LANE
ELEVATOR
WITH RING
HANDLE**

10.5" overall

length 265mm

820-6196-05



ILIAC WING RETRACTOR

15" 740-1501-0

18" 740-1801-0



LOTKE OSTEOTOME

750-9512-0

For removing posterior Osteophytes.



OSTEOTOMES, GOUGES & CHISELS

MOTTA CHISELS

SIZE

1	22mm	756-9501-0
2	33mm	756-9502-0
3	39mm	756-9503-0
4	47mm	756-9504-0

For Chiari osteotomy procedure.



GOATS FOOT RETRACTOR

756-1053-0



AUFRANC ACETABULAR GOUGE

756-1128-1

OSTEOTOMES, GOUGES & CHISELS



HARVESTING GOUGE

10" overall length 5"
handle 250mm

5/16" 8mm 753-0516-0

*Available with 9" handle
upon request*



MINI OSTEOTOMES

7.5" overall length 190mm

- 2mm 750-7502-0
- 4mm 750-7504-0
- 6mm 750-7506-0
- 8mm 750-7508-0

9" handle available upon request

Curved Mini Osteotomes available upon request



NAVICULAR GOUGE

8.5" length 215mm

755-0803-0



SHAMIM CORPORATION

SMITH PETERSON OSTEOTOME

8" length 200mm

SIZE	MM	STRAIGHT	CURVED
1/4"	6mm	750-0825-0	750-0825-1
3/8"	9mm	750-0838-0	750-0838-1
1/2"	13mm	750-0812-0	750-0812-1
5/8"	16mm	750-0858-0	750-0858-1
3/4"	19mm	750-0834-0	750-0834-1
1"	25mm	750-0810-0	750-0810-1



SMITH PETERSON GOUGE

8" length 200mm

SIZE	MM	STRAIGHT	CURVED
------	----	----------	--------

OSTEOTOMES, GOUGES & CHISELS

1/4"	6mm	753-0814-0	753-0814-1
3/8"	9mm	753-0838-0	753-0838-1
1/2"	13mm	753-0812-0	753-0812-1
5/8"	16mm	753-0858-0	753-0858-1
3/4"	19mm	753-0834-0	753-0834-1
1"	25mm	753-0810-0	753-0810-1



HIBBS GOUGE

9.5" length 240mm

SIZE	MM	STRAIGHT	CURVED
1/4"	6mm	753-0914-0	753-0914-1
3/8"	9mm	753-0938-0	753-0938-1
1/2"	13mm	753-0912-0	753-0912-1
5/8"	16mm	753-0958-0	753-0958-1
3/4"	19mm	753-0934-0	753-0934-1
1"	25mm	753-0910-0	753-0910-1

MALLETS & TAMPS

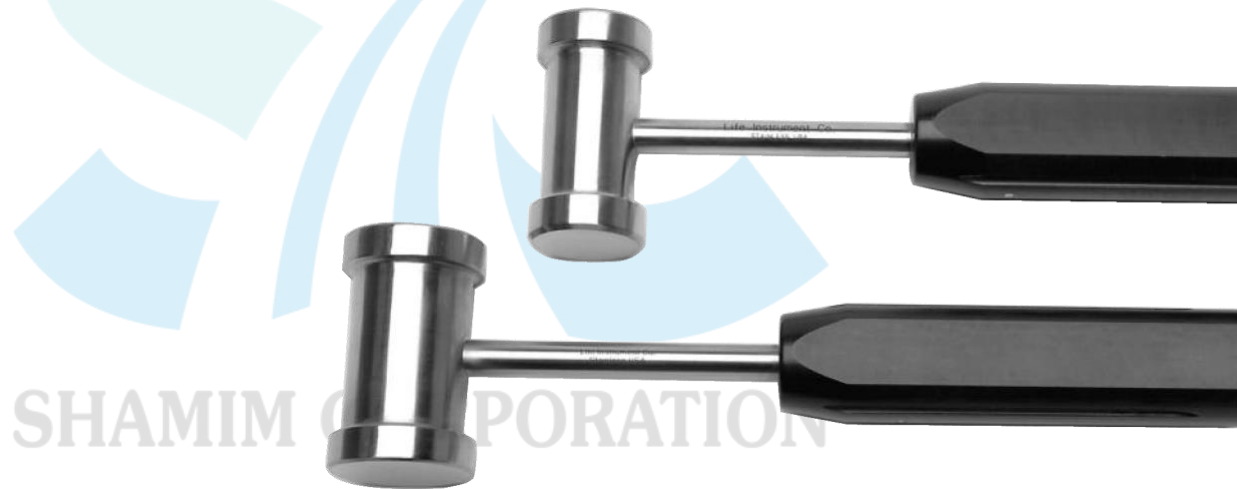

SMITH PETERSON MALLETS

9" overall length 230mm

Small 761-9017-0

Large 761-9028-0



TORONTO MALLETS
9" overall length 230mm

Metal 32 oz. 760-9032-0

Plastic 24 oz. 760-9024-0

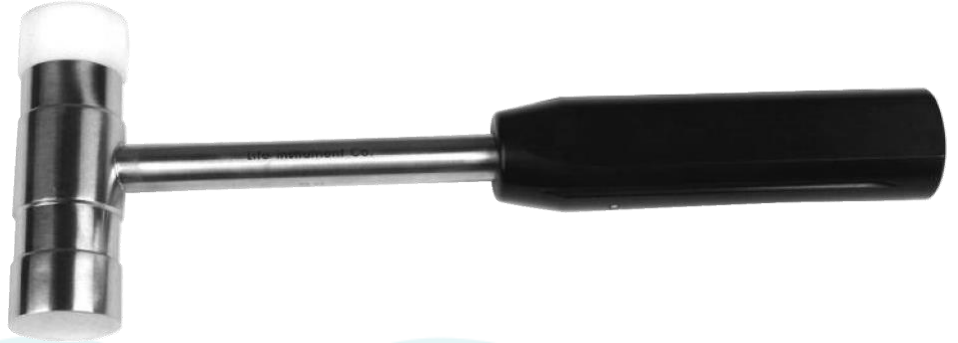

MALLET

Nylon one side

30mm diameter

10" overall

length 250mm

761-1030-0

SHAMIM CORPORATION

MALLETS & TAMPS



763-9505-0



763-9513-0



763-9510-0



763-1212-0

BONE TAMPS

9.5" length 240mm

Rectangular Tamp	5mm	763-9505-0
Round Bone Tamp	13mm	763-9513-0
Offset Bone Tamp	10mm	763-9510-0

BONE IMPACTOR

12" length 300mm

12mm x 6mm

763-1212-0

SHAMIM CORPORATION



TAMP 12" length 300mm

9mm x 9mm

763-1209-0

RADIOLUCENT INSTRUMENTS



CARBON FIBER PEEK BLADES

	SIZE	20mm width	25mm width
	50mm	649-2050-0	649-2550-0
	70mm	649-2070-0	649-2570-0
	90mm	649-2090-0	649-2590-0
	110mm	649-2011-0	649-2511-0

Additional blade sizes available upon request. Please visit our website at www.lifeinstruments.com.

RADIOLUCENT INSTRUMENTS CARBON FIBER RETRACTORS



HOHMANN STYLE RETRACTOR 9.5" overall length

10mm 643-9510-0 18mm 643-9518-0 25mm 643-9525-0



CLOWARD RETRACTOR 100mm blade

20mm 648-7520-0



**EXTRA LONG HOHMANN RETRACTOR
12" overall length**

25mm 643-1225-0



ILIAC WING RETRACTOR 15" overall length



FEMORAL RETRACTOR 16" overall length

640-1501-0

640-1630-0

SUCTION TUBES



FRAZIER SUCTION TUBES

7" from bend

6FR	791-0006-1
8FR	791-0008-1
10FR	791-0010-1
12FR	791-0012-1
14FR	791-0014-1

8" from bend

10FR	791-0010-1-8
12FR	791-0012-1-8

10" from bend

10FR	791-0010-1-10
12FR	791-0012-1-10

Custom lengths available upon request.

*** Large Aluminum Handle for Excellent Control ***

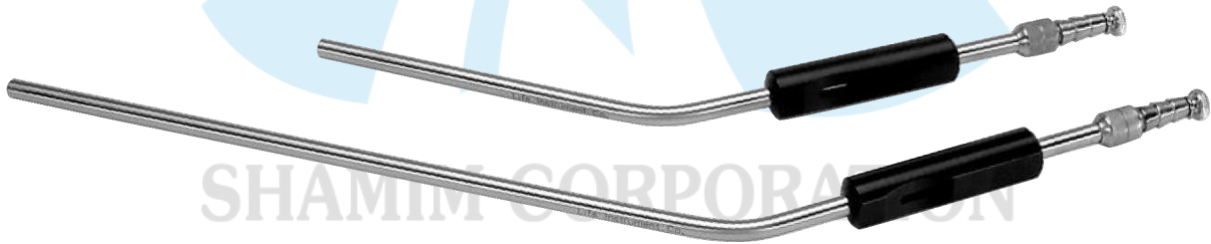

ASDOURIAN SUCTION TUBES

20 FR

5" from the bend	791-1005-0
9" from the bend	791-1010-0

OTHER



JEFFERSON FORCEPS

7" length 175mm

1 x 2 Teeth	780-7012-0
Serrated	780-7013-0



"WHITE" RUSSIAN FORCEP

New forcep designed to facilitate collection, delivery and packing of bone graft. Very useful for bone grafting adjacent to instrumentation, under rods and crosslinks. *Designed by Andrew White, M.D.*

8" 780-8005-0 10" 780-1005-0



Tamp End

*** NEW ***



WIRE TWISTER

781-1000-1

OTHER

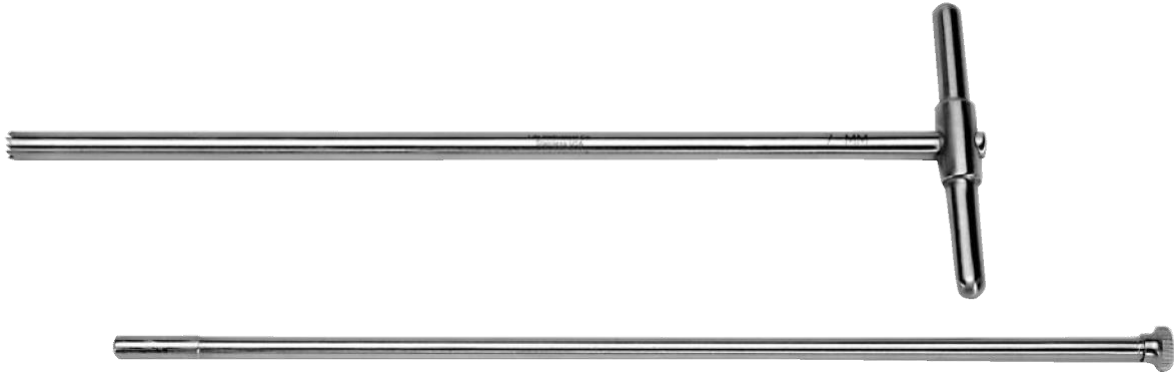

TREPHINES



FUNNEL Stainless Steel

Bone Funnel Cup

8.5" Tube

6" length 150mm

6mm 756-0606-0

Plunger 756-0606-1

9" length 230mm

7mm 756-0907-0

8mm 756-0908-0

9mm 756-0909-0

Plungers:

7mm 756-0907-1

8mm 756-0908-1

9mm 756-0909-1

12" length 300mm

7mm 756-1207-0

8mm 756-1208-0

9mm 756-1209-0

Plungers

7mm 756-1207-1

8mm 756-1208-1

9mm 756-1209-1

706-0302-0

706-8508-1

6.5" Tube

706-6508-1

Cup disassembles from tube for easy cleaning. * Sold Separately *



PLUNGER

706-8508-2 for 8.5" Tube
706-6508-2 for 6.5" Tube

OTHER

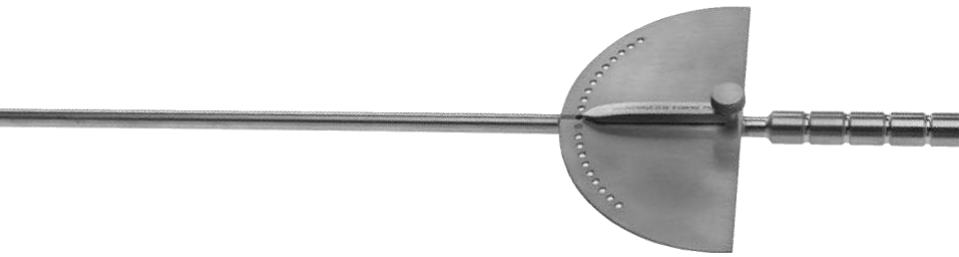

HIP ALIGNMENT GUIDE

704-0001-0



CARBIDE TIP PUNCH

706-1000-0

SHAMIM CORPORATION

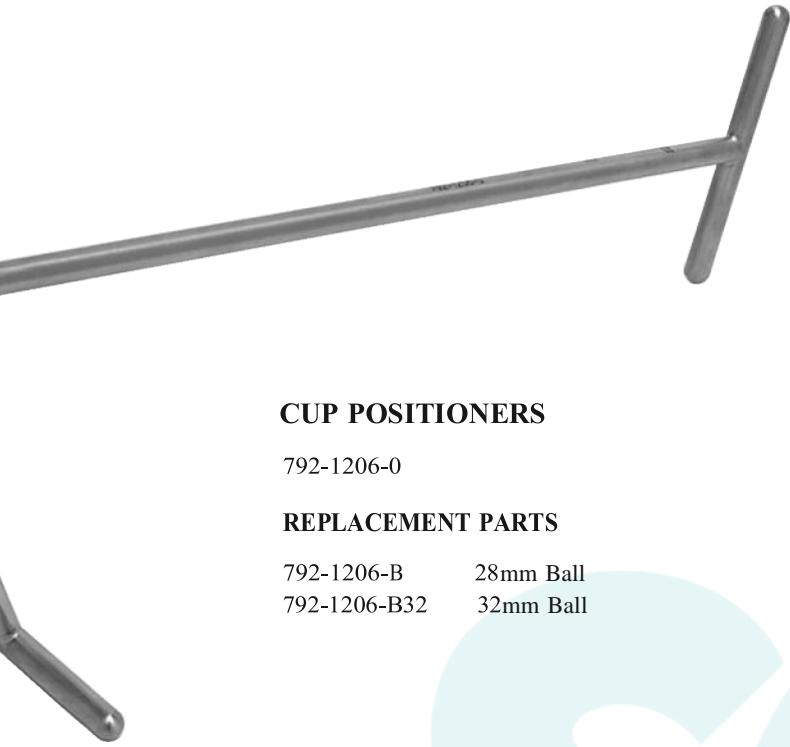

CUP POSITIONERS

792-1206-0

REPLACEMENT PARTS

792-1206-B 28mm Ball
792-1206-B32 32mm Ball



SHAMIM CORPORATION

OTHER





**LIFE INSTRUMENT ARM WITH
UNIVERSAL ATTACHMENT
Table Clamp Included**

400mm column 703-1601-0

SHAMIM CORPORATION



**LIFE INSTRUMENT L-SHAPE COLUMN
WITH ARTICULATING ARM
Table Clamp Included**

L-Shape Column (450x100mm) with Articulating Arm (400mm extension)

703-1801-0 with Universal Attachment

